

# BIM-NST-AP6X-V1131

## Magnetic Field Sensor – For Pneumatic Cylinders

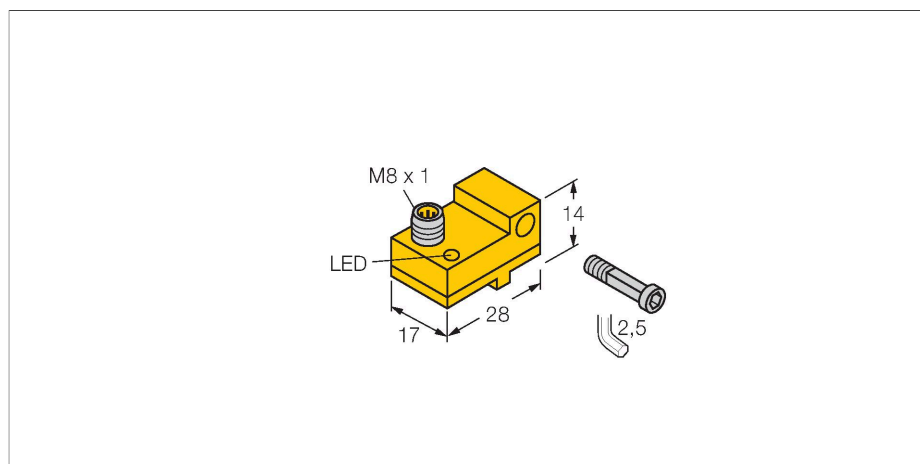

### Features

- Plastic, PA12-GF30
- Magnetic-inductive sensor
- DC 3-wire, 10...30 VDC
- NO contact, PNP output
- Male connector, M8 x 1

### Wiring diagram

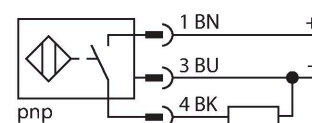

### Technical data

Type	BIM-NST-AP6X-V1131
ID	4685800
<b>General data</b>	
Pass speed	≤ 10 m/s
Repeatability	≤ ± 0.1 mm
Temperature drift	≤ 0.1 mm
Hysteresis	≤ 1 mm
<b>Electrical data</b>	
Operating voltage	10...30 VDC
Residual ripple	≤ 10 % U <sub>ss</sub>
DC rated operational current	≤ 200 mA
No-load current	15 mA
Residual current	≤ 0.1 mA
Isolation test voltage	≤ 0.5 kV
Short-circuit protection	yes / Cyclic
Voltage drop at I <sub>o</sub>	≤ 1.8 V
Wire breakage/Reverse polarity protection	yes / Complete
Output function	3-wire, NO contact, PNP
Switching frequency	1 kHz
<b>Mechanical data</b>	
Design	Rectangular, NST
Dimensions	28 x 17 x 14 mm
Housing material	Plastic, PA12-GF30
Active area material	Plastic, PA12-GF30
Electrical connection	Connector, M8 × 1

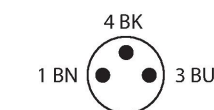



### Functional principle

Magnetic field sensors are activated by magnetic fields and are especially suited for piston position detection in pneumatic cylinders. Based on the fact that magnetic fields can permeate non-magnetizable metals, it is possible to detect a permanent magnet attached to the piston through the aluminium wall of the cylinder.

## Technical data

Environmental conditions	
Ambient temperature	-25...+70 °C
Vibration resistance	55 Hz (1 mm)
Shock resistance	30 g (11 ms)
Protection class	IP67
MTTF	2283 years acc. to SN 29500 (Ed. 99) 40 °C
Mounting on the following profiles	
Cylindrical design	 ###
Switching state	LED, Yellow
Included in delivery	1 x screw M3x20, 1 x tension bolt, 1 x spring washer

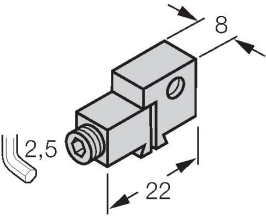
## Accessories

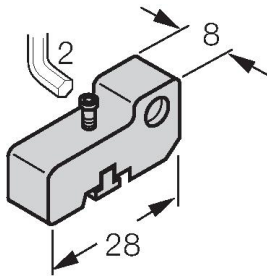
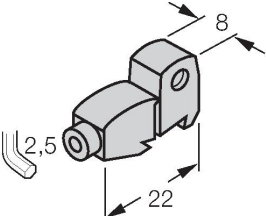
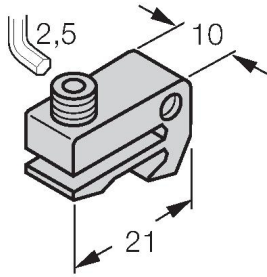
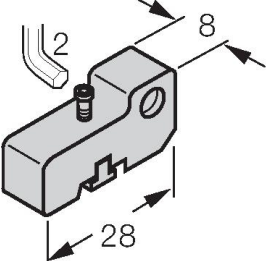
<p><b>KLN3</b></p> 	<p><b>6970504</b></p> <p>Mounting bracket for mounting magnetic field sensors on dovetail groove cylinders or  T-groove cylinders; clamping width: 5.2...13.5 mm; material: Anodized aluminum</p>	<p><b>KLN-SMC</b></p> 	<p><b>6970503</b></p> <p>Mounting bracket for mounting magnetic field sensors on SMC cylinders; clamping width 4 mm; material: Anodized aluminum</p>
<p><b>KLF1</b></p> 	<p><b>6970401</b></p> <p>Mounting bracket for mounting magnetic field sensors on profile cylinders with external dovetail guide; for all cylinder diameters, material: Anodized aluminum</p>	<p><b>KLF2</b></p> 	<p><b>6970402</b></p> <p>Mounting bracket for mounting magnetic field sensors on profile cylinders (IMI Norgren); cylinder diameter: 32...100 mm; material: Anodized aluminum</p>
<p><b>SMC-325</b></p> 	<p><b>A3106</b></p> <p>Mounting bracket for mounting magnetic field sensors on SMC cylinders; clamping width 4 mm; material: Anodized aluminum</p>		