

T30R Series

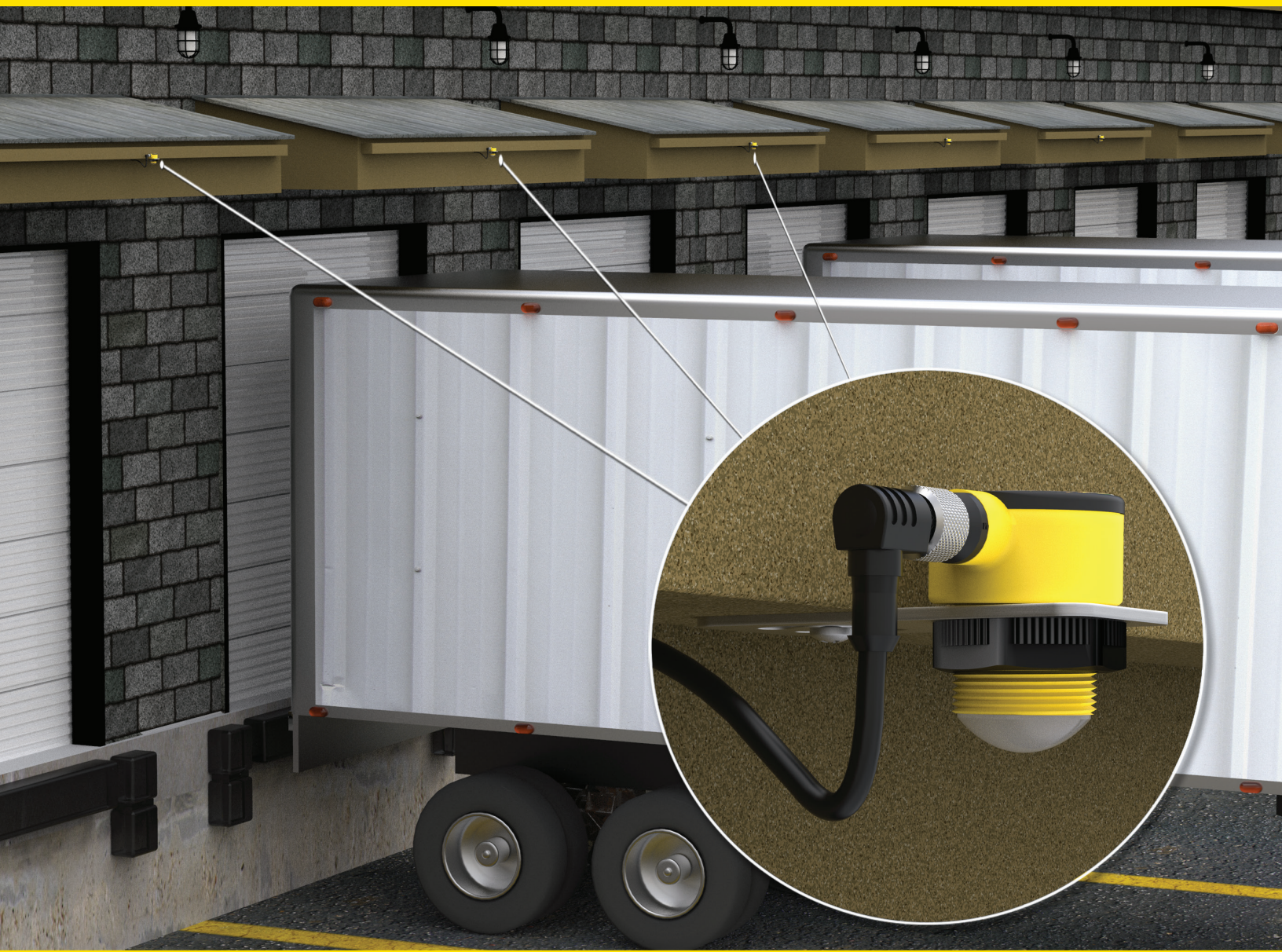

Detecting Where Others Cannot

- Robust, longer range alternative to ultrasonics
- More precise and reliable alternative to traditional 24 GHz radar
- Easy set up – Simple integration



Bridging the Gap Between Ultrasonics and Radar



	Range	Dead Zone	Outdoor Robustness	Measurement Precision	Crosstalk Immunity
Other Banner Radar (24 GHz)	✓		✓		✓
T30R (122 GHz)	✓	✓	✓	✓	✓
Ultrasonics		✓		✓	

Robust, Longer Range Alternative to Ultrasonics



Ideal for outdoor applications

- Resistant to rain, snow, fog, steam, or sunlight
- IP67-rated

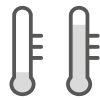

Temperature stability

- Radar (radio waves) not affected by temperature changes like Ultrasonic (sound waves)
- Consistent measurement from -40 to 65 °C

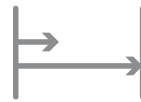

Detect near or far

- Sensing range of 150 mm to 15 m

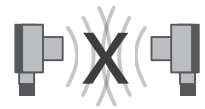

No crosstalk

- No problem mounting multiple sensors close together

More Precise and Reliable Alternative to Traditional 24 GHz Radar



Accurate measurement

- Linearity and repeatability less than 1 cm



Senses more objects

- 122 GHz radar detects a wider range of low dielectric materials to solve more applications

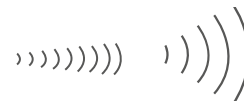

Precise measurement up to 15 meters

- Sensors use two independent, adjustable sensing zones and operate at 122 GHz, which enables higher precision measurements with a narrow or wide beam patterns up to 15 meters away

Easy Set Up – Simple Integration



Flexible set-up and Configuration

- Optional PC Configuration, push buttons, IO-Link or remote teach

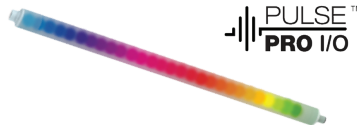

Direct integration with Banner lights

- No separate controller needed

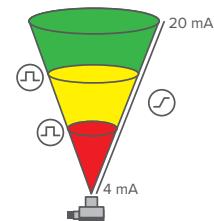

Solve more applications

- Dual discrete outputs for slow and stop
- Analog and IO-Link for absolute measurement values
- Available in 15°x15° and 45°x45° beam patterns

Beam Pattern Considerations

Radar Sensors are available in narrow and wide beam patterns. Narrow beam patterns avoid false detection of objects outside of the region of interest and allow for a more precise measurement, while wide beam patterns provide coverage of larger areas and provide more robust detection of irregular surfaces and targets presented at steep angles.

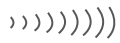

Narrow Beam Applications

- Drive-through
- Gantry crane
- Overhead crane
- Loading docks

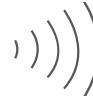

Wide Beam Applications

- Mobile equipment collision avoidance
- Vehicle detection: Train, car, boats

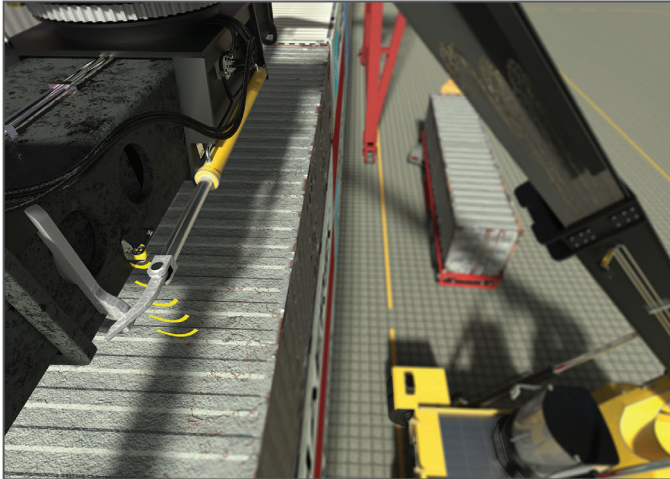

Provide Reliable Position Feedback

Dual Discrete outputs are available for slow and stop positions for port equipment such as reach stackers and container handlers. Analog and IO-Link outputs are also available for absolute distance measurement values for ground support equipment such as baggage handlers or de-icing vehicles.



Reliable Vehicle Detection in Challenging Environmental Conditions

Banner radar is resistant to rain, wind, and snow and has a wide operating temperature making it ideal for vehicle detection at loading docks, tolls, gates, and car washes.



Reliable Collision Avoidance

The T30R measures the distance of ground support equipment from the aircraft and signals an alert when it reaches a programmed distance to prevent collisions. With the 45°x45° beam pattern, the T30R can detect curved surfaces, such as an airplane, more reliably since a smaller beam can be deflected by the target's curvature.

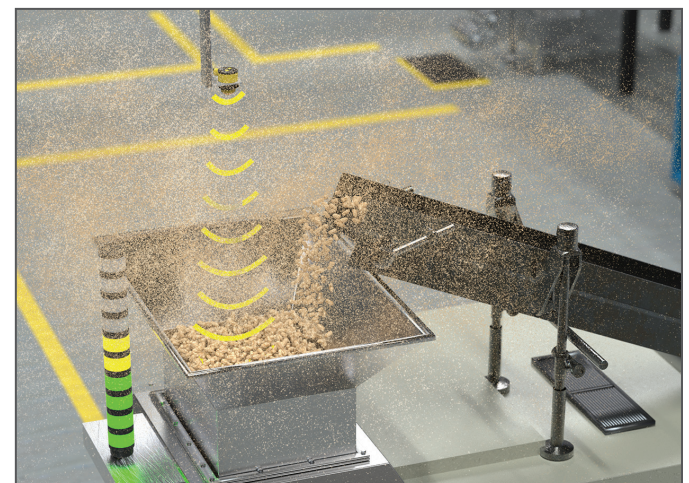

Challenging Level Management

The T30R can see through steam, dust, and debris build up on the sensor face where ultrasonics may struggle. Banner's T30R also measures up to 15 m for larger tanks where ultrasonic range isn't sufficient.

Pulse Pro output for direct integration with Banner lights. Direct process feedback which only requires power; no controller needed.



T30R Radar Sensor

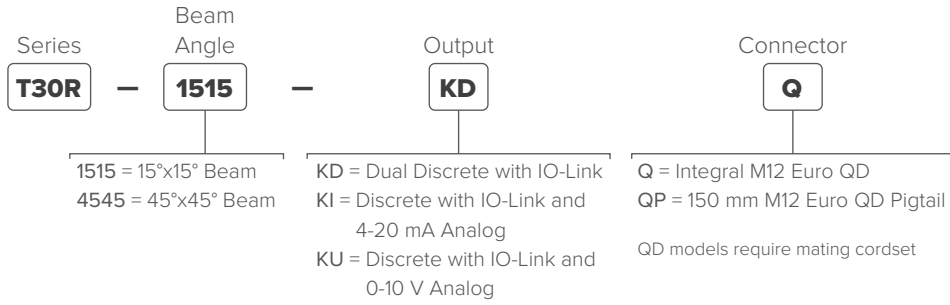

Specifications

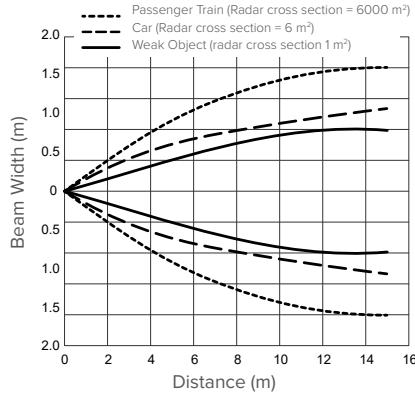

	1515	4545
Detection Range	0.15 to 15 m (0.5 to 49.2 ft)	0.3 to 10 m (1.0 to 32.8 ft)
Measurement Range	0.2 to 15 m (0.6 to 49.2 ft)	0.3 to 10 m (1.0 to 32.8 ft)
Linearity*	< ±4 mm	
Repeatability**	< 1 mm	
Response Time	Analog Update Rate: 2 ms Discrete Output Response: 6 ms	

* At ranges > 0.5 m, from 0.3 to 0.5 m, linearity < ±15 mm
** Repeatability < 10 mm at Excess Gain < 10x

† For the most reliable detection, the target should be larger than half of the beam width.

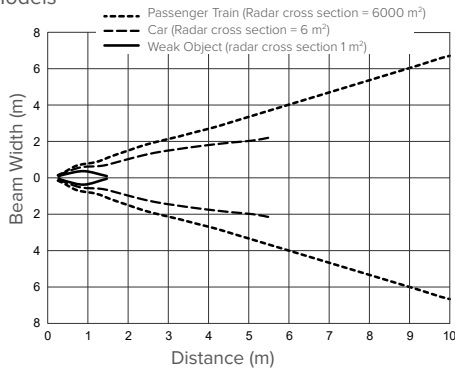
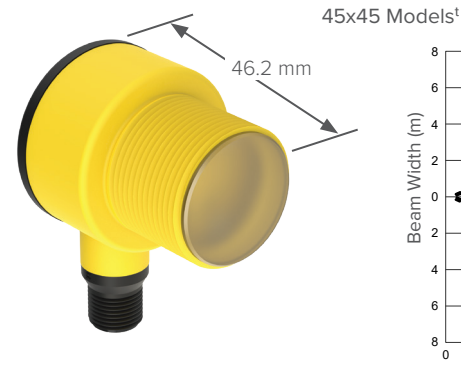

Accessories



M12 Straight connector models listed; for right-angle, add RA to the end of the model number (example, MQDEC2-506RA)

5-Pin	5-Pin Double-Ended
MQDEC2-506	MQDEC3-506SS
2 m (6.5 ft)	2 m (6.5 ft)
MQDEC2-515	MQDEC3-515SS
5 m (15 ft)	5 m (15 ft)
MQDEC2-530	MQDEC3-530SS
9 m (30 ft)	9 m (30 ft)



Banner Engineering Corp.

9714 10th Avenue North • Minneapolis, MN 55441 • 1-888-373-6767 • www.bannerengineering.com