

Gehäuse ø 22

IP66
 Kontakte: Bodenbefestigung mit Schraubanschluss
 Nach Norm IEC 60947-5-1
 Beschriftung auf dem Gehäuse
 Zubehör (Seite 70)
 Anfrageformular (Seite 94)

 Technische Daten (Seite 98)

► GEHÄUSE MIT 1 TASTER (FORTSETZUNG)

DREHSCHALTER MIT SCHLÜSSEL

Bestell-Nr.

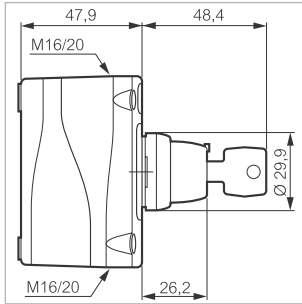

Kontakt

Bezeichnung

Lieferung mit 2 Schlüsseln Nr. 455
 2 Schaltstellungen
 Schlüssel abziehbar in Stellung 0-1
 45°

● Schwarz NO 

○
|

LBX12610

LBX12610

NOT-AUS TASTER ø 40 - RASTEND

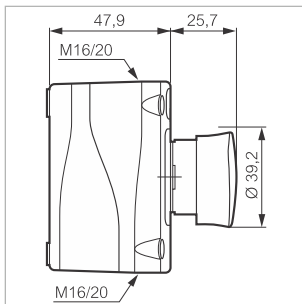

Drehentriegelung

Bestell-Nr.



Kontakt

Bezeichnung

● Rot NC 
 ● Rot NC 
 ● Rot NC 

ARRET D'URGENCE
 NOT-AUS
 EMERGENCY STOP

LBX10310
LBX10410
LBX10510

Kontaktelmente frontbefestigt (Formular Seite 94)

LBX10510

NOT-HALT TASTER ø 40 ISO 13850 - RASTEND

Drehentriegelung



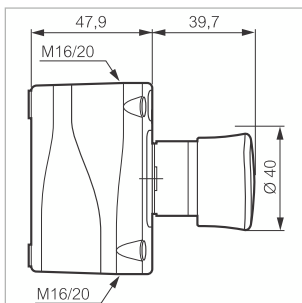

Bestell-Nr.





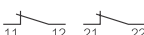

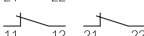

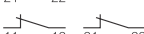
Überlistungssicher nach IEC 60947-5-5 / ISO 13850

Kontakt

Bezeichnung

● Rot NC 
 ● Rot 2 NC 
 ● Rot NC 
 ● Rot 2 NC 
 ● Rot NC 
 ● Rot 2 N 

ARRET D'URGENCE +  LBX17101
 ARRET D'URGENCE +  LBX17102
 NOT- HALT +  LBX17201
 NOT- HALT +  LBX17202
 EMERGENCY STOP +  **LBX17301**
 EMERGENCY STOP +  **LBX17302**

LBX17201

Kontaktelmente frontbefestigt (Formular Seite 94)

Gehäuse Ø 22

IP 66
 Kontakte: Bodenbefestigung mit Schraubanschluss
 Nach Norm IEC 60947-5-1
 Beschriftung auf dem Gehäuse
 Zubehör (Seite 70)
 Anfrageformular (Seite 94)

 Technische Daten (Seite 98)

► GEHÄUSE MIT 1 TASTER (FORTSETZUNG)







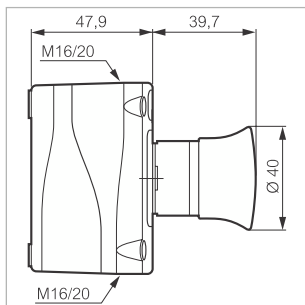



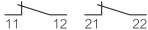

NOT-HALT TASTER Ø 40 ISO 13850 - RASTEND

Zugentriegelung

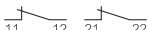
Bestell-Nr.



Überlistungssicher nach IEC 60947-5-5 / ISO 13850

	Kontakt	Bezeichnung	
● Rot	NC 	ARRET D'URGENCE + 	LBX15101
● Rot	2 NC 	ARRET D'URGENCE + 	LBX15102
● Rot	NC 	NOT- HALT + 	LBX15201
● Rot	2 NC 	NOT- HALT + 	LBX15202
● Rot	NC 	EMERGENCY STOP + 	LBX15301
● Rot	2 NC 	EMERGENCY STOP + 	LBX15302

LBX15101

Kontakt hinter Deckel befestigt (Formular Seite 94)







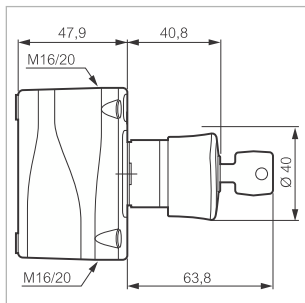



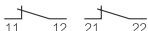

NOT-HALT TASTER MIT SCHLÜSSEL Ø 40 ISO 13850 - RASTEND

Schlüssellentriegelung

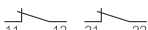
Bestell-Nr.

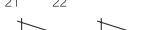

Überlistungssicher nach IEC 60947-5-5 / ISO 13850
 Lieferung mit 2 Schlüsseln Nr. 455

	Kontakt	Bezeichnung	
● Rot	NC 	ARRET D'URGENCE + 	LBX11101
● Rot	2 NC 	ARRET D'URGENCE + 	LBX11102
● Rot	NC 	NOT- HALT + 	LBX11201
● Rot	2 NC 	NOT- HALT + 	LBX11202
● Rot	NC 	EMERGENCY STOP + 	LBX11301
● Rot	2 NC 	EMERGENCY STOP + 	LBX11302

LBX11302

Kontakt hinter Deckel befestigt (Formular Seite 94)



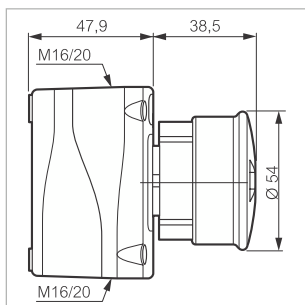

NOT-HALT TASTER Ø 54 ISO 13850 - RASTEND

Zugentriegelung mit Zustandsanzeige

Bestell-Nr.

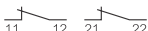

Überlistungssicher nach IEC 60947-5-5 / ISO 13850
 Doppelte Zustandsanzeige: mittels gelben Ring und im Sichtfenster

	Kontakt	Bezeichnung	
● Rot	NC 	STOP - 	LBX14201
● Rot	2 NC 	STOP - 	LBX14202

LBX14201

Kontakt hinter Deckel befestigt (Formular Seite 94)

Bestellnummern in Fettdruck: ab Lager erhältliche Produkte