

Product information FMQ

PHARMA

FOOD

Magnetic-Inductive Flow Meter FMQ

Application/Specified usage

- Magnetic-inductive flowmeter for the measurement of flow rate and volume in food and pharmaceutical applications
- Suitable for liquids, mash and pastes with a minimum conductivity of $5 \mu S/cm$
- Precise measurement of media containing solids (< 5 % solid particle content)
- Measurement range from 30 l/h to 640 000 l/h
- Suitable for dosing and filling applications

Hygienic design/Process connection

- Conformity with 3-A standard
- All wetted materials are FDA-conform
- Sensor made entirely of stainless steel
- Meter tube in transmitter with PFA coating
- Vacuum-tight and piggable
- Electrodes made of stainless steel 1.4404 (AISI 316L)
- Sensor available with or without process connections

Special features/Advantages

- CIP/SIP cleaning up to $130 \text{ }^\circ\text{C}$ ($266 \text{ }^\circ\text{F}$) for max. 30 minutes
- High measurement accuracy even at low flow rates
- Simple and user-friendly parameterization
- Switch input for resetting the quantity-/volume counter (option)
- Automatic empty pipe detection avoids undefined readings for empty pipes
- PFA lining for maximum resistance to aggressive substances such as acids and bases
- Vacuum-tight, rigid meter tube lining, even at high temperatures
- Swiveling housing head with illuminated graphic display
- Operation of device via optical keys without opening the housing
- Minimal maintenance and care requirements
- Pharmaceutical version available with all necessary certificates

Communication

4...20 mA

FMQ flowmeter



Functional principle

The principle behind this measurement method is Faraday's law of induction. This law states that a voltage is induced in a conductor that moves in a magnetic field. In the magnetic-inductive measurement method, the flowing, conductive medium acts as the conductor. Two vertically positioned field coils generate a constant magnetic field. The voltage induced in the flowing medium is measured by two stainless steel electrodes that are arranged horizontally. The voltage is directly proportional to the flow rate and can be expressed as the flow volume using the nominal tube width. The determined measurement values are made available as a counting pulse and 4...20 mA standard signal.

Magnetic-inductive measurement

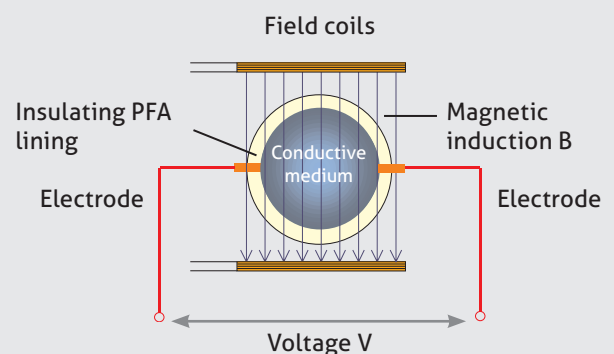

Features

- Supply voltage: 24 V DC
- Outputs
 - 1 digital output
 - 1 analog output
- Optional switch input

Rotating head unit

- Integrated graphic display, illuminated
- Display area 4 x 90° rotatable
- Operation via optical button (not necessary to open housing)

Electrical connection

M12 plug

Measurement transmitter

- PFA liner, vacuum-tight, piggable, FDA-approved
- Measurement electrodes, 1.4404 (AISI 316L)

Meter tube

Aseptic flange DIN 11864-2, form A

Pipe standard

- DIN 11850 series 2
- DN 10 ... DN 150





Process connection

- Wide variety of process connections available
- Available for food or pharmaceutical applications

**Note**

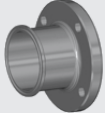
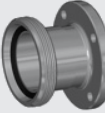
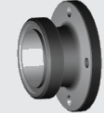
The display comes with a power saving mode. The background lighting automatically switches off after 30 minutes, while the measured values continue to be displayed. For better readability, however, the lighting can be switched on again at any time by pressing the optical keys.

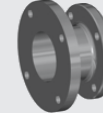
Process adapters (optional available)

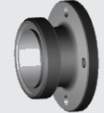
							
SS Weld flange	TC Tri-Clamp	GG Milk pipe fitting	HH Aseptic fitting	VN Varivent	FG FG hygienic flange	DF DIN flange	SM SMS threaded connector

Technical data		
Transmitter	Measuring principle Measurement range Nominal width Pipe standard	Magnetic-inductive 0.15...10 m/s DN10...DN150 DIN 11850 Series 2
Process connection (optional)	Pipe standards	Food: DIN 11850 Series 2, OD tube (ASME BPE) Pharma: DIN 11866 Series A, B, C
Material	Food seal Pharma seal Transmitter housing Transmitter lining Food electrodes Pharma electrodes Converter housing Sight glass M12 connector	EPDM, FDA number 21 CFR 177.2600 EPDM with USP Class VI 1.4301 (AISI 304), blasted PFA, FDA number 21 CFR 177.1550 1.4404 (AISI 316L) 1.4404 (AISI 316L) with 3.1 material certificate 1.4404 (AISI 316L) PMMA (acrylic glass) Plastic Optional: 1.4301 (AISI 304)
Pipe connection	Food Pharma	1.4404 (AISI 316L) 1.4435 (AISI 316L) with 3.1 material certificate
Temperature ranges	Ambient Process CIP / SIP cleaning	-25...+60 °C (-13...140 °F) 0...+100 °C (32...212 °F) up to 130 °C (266 °F) max. 30 min
Protection class		IP 67
Transmitter	LC display Electrical connection Supply voltage Power consumption	Graphic display 46 mm x 23 mm, backlit M12 connector 24 V DC ±10 % Max. 2.5 W (without display) Max. 3.0 W (with display)
Measurement accuracy		±0.5 % ±2 mm/s, under reference conditions as per DIN EN 29104 and VDI/VDE 2641
Product conductivity	Standard Demineralized water	> 5 µS/cm > 20 µS/cm
Pulse output (volume counter)	1x optocoupler, passive	24 V / 20 mA, pulse sequence max. 1 kHz
Switch input (optional) (reset volume counter)		9...24 V DC
Analog output (flow rate)	Active Ohmic resistance	4...20 mA Max. 500 Ω

Note

This product information is not an operating manual. Please note the information on device safety, installation and operation in the product operating manual.

FMQ dimensions and optional process connections for food

FMQ dimensional drawing

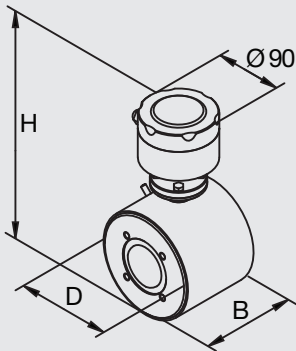

Dimensions, measurement range and weight: FMQ without process connection

Transmitter type	DN transmitter	B	D	H	Measurement range [l/h]	Sensor weight [kg]
FT010	10	104	90	201	30...3,000	4
FT015	15	104	90	201	70...7,000	4
FT025	25	104	90	201	180...18,000	4
FT032	32	104	105	216	300...30,000	5
FT040	40	104	105	216	450...45,000	5
FT050	50	104	130	241	700...70,000	6
FT065	65	160	130	241	1,200...120,000	6
FT080	80	160	155	266	1,800...180,000	10
FT100	100	200	170	281	2,800...280,000	15
FT125	125	250	220	331	4,400...440,000	20
FT150	150	300	220	331	6,400...640,000	23

FMQ dimensional drawing

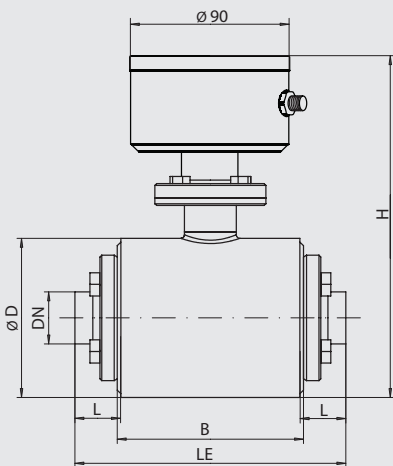

Dimensions: pipe standard OD tube (ASME-BPE) and transmitter type

DN pipe	Pipe dimension Da x S	Installation length LE			Transmitter type
		SS	TC as per ASME-BPE (plate size)	SM	
1/2"	12.7 x 1.65	152	170.8 (25)	-	FT010
3/4"	19.05 x 1.65	152	204.6 (25)	-	FT015
1"	25.4 x 1.65	152	202.8 (50)	182	FT025
1½"	38.1 x 1.65	152	202.8 (50)	192	FT040
2"	50.8 x 1.65	152	202.8 (64)	192	FT050
2½"	63.5 x 1.65	208	229.4 (77)	256	FT065
3"	76.2 x 1.65	212	252.6 (91)	260	FT080
4"	101.6 x 2.11	252	299.2 (119)	312	FT100
6"	152.4 x 2.77	356	399.2 (183)	-	FT150

Dimensions: pipe standard DIN 11850 Series 2 and transmitter type

DN pipe	Pipe dimension Da x S	Installation length LE							Transmitter type
		SS	TC as per DIN 32676 (plate size)	GG	HH	DF	VN	FG	
10	13 x 1.5	152	200 (34)	200	190	200	200	200	FT010
15	19 x 1.5	152	200 (34)	200	190	200	200	200	FT015
25	29 x 1.5	152	200 (50)	200	204	225	200	200	FT025
32	35 x 1.5	152	200 (50)	200	212	225	200	200	FT032
40	41 x 1.5	152	200 (50)	200	214	225	200	200	FT040
50	53 x 1.5	152	200 (64)	200	214	225	200	200	FT050
65	70 x 2.0	208	256 (91)	256	280	306	256	256	FT065
80	85 x 2.0	212	255 (91)	255	296	305	255	255	FT080
100	104 x 2.0	252	340 (119)	340	352	340	340	340	FT100
125	129.0 x 2.0	306	360 (153)	360	-	416	360	360	FT125
150	154.0 x 2.0	356	410 (183)	410	-	466	410	410	FT150

FMQ dimensions and optional process connections for pharma

FMQ dimensional drawing

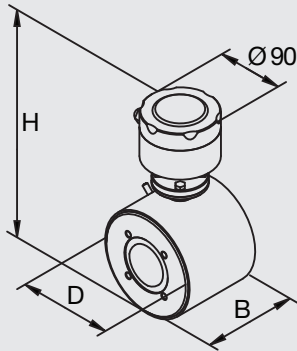

Dimensions, measurement range and weight: FMQ without process connection

Transmitter type	DN transmitter	B	D	H	Measurement range [l/h]	Sensor weight [kg]
FT010	10	104	90	201	30...3,000	4
FT015	15	104	90	201	70...7,000	4
FT025	25	104	90	201	180...18,000	4
FT032	32	104	105	216	300...30,000	5
FT040	40	104	105	216	450...45,000	5
FT050	50	104	130	241	700...70,000	6
FT065	65	160	130	241	1,200...120,000	6
FT080	80	160	155	266	1,800...180,000	10
FT100	100	200	170	281	2,800...280,000	15
FT125	125	250	220	331	4,400...440,000	20
FT150	150	300	220	331	6,400...640,000	23

FMQ dimensional drawing

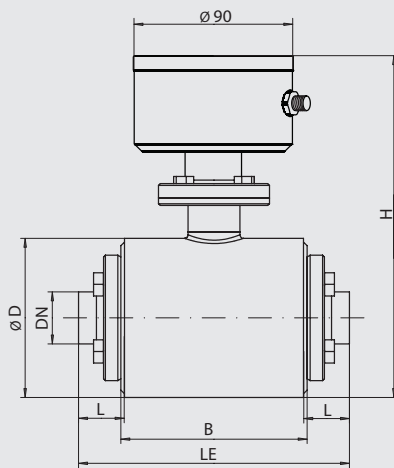

Installation length LE for FMQ as per DIN 11866 Series A

DN pipe	Pipe dimension Da x S	Installation length LE			Transmitter type
		SS	Tri-Clamp as per DIN 32676 (plate size)	HH	
10	13 x 1.5	152	200 (34)	190	FT010
15	19 x 1.5	152	200 (34)	190	FT015
25	29 x 1.5	152	200 (50)	204	FT025
32	35 x 1.5	152	200 (50)	212	FT032
40	41 x 1.5	152	200 (50)	214	FT040
50	53 x 1.5	152	200 (64)	214	FT050
65	70 x 2.0	208	256 (91)	280	FT065
80	85 x 2.0	212	255 (106)	296	FT080
100	104 x 2.0	252	340 (119)	352	FT100
125	129 x 2.0	306	360 (155)	-	FT125
150	154 x 2.0	356	410 (183)	-	FT150

Installation length LE for FMQ as per DIN 11866 Series B

DN pipe	Pipe dimension Da x S	Installation length LE			Transmitter type
		SS	Tri-Clamp as per DIN 32676 (plate size)	HH	
8	13.5 x 1.6	152	200 (25)	190	FT010
10	17.2 x 1.6	152	200 (25)	190	FT015
15	21.3 x 1.6	152	200 (50)	194	FT025
20	26.9 x 1.6	152	200 (50)	204	
25	33.7 x 2.0	152	200 (50)	212	FT032
32	42.4 x 2.0	152	200 (64)	214	FT040
40	48.3 x 2.0	152	200 (64)	214	FT050
50	60.3 x 2.0	152	200 (77)	224	
65	76.1 x 2.0	208	256 (91)	292	FT065
80	88.9 x 2.3	212	255 (106)	312	FT080
100	114.3 x 2.77	252	340 (119)	-	FT100
125	139.7 x 2.6	306	360 (155)	-	FT125
150	168.3 x 2.6	356	410 (183)	-	FT150

Installation length LE for FMQ as per DIN 11866 Series C

DN pipe	Pipe dimension Da x S	Installation length LE			Transmitter type
		SS	Tri-Clamp as per ASME-BPE (plate size)	HH	
1/2"	12.7 x 1.65	152	170.8 (25)	190	FT010
3/4"	19.05 x 1.65	152	204.6 (25)	190	FT015
1"	25.4 x 1.65	152	202.8 (50)	204	FT025
1½"	38.1 x 1.65	152	202.8 (50)	214	FT040
2"	50.8 x 1.65	152	202.8 (64)	214	FT050
2½"	63.5 x 1.65	208	229.4 (77)	280	FT065
3"	76.2 x 1.65	212	252.6 (91)	296	FT080
4"	101.6 x 2.11	252	299.2 (119)	352	FT100
6"	152.4 x 2.77	356	399.2 (183)	-	FT150

Note

All dimensions in millimeters [mm].



GG | Milk pipe fitting DIN 11851

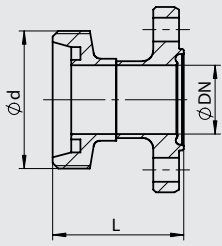

Ø DN	L	Ø d
10	49.5	Rd 28 x 1/8"
15	49.5	Rd 34 x 1/8"
25	49.5	Rd 52 x 1/6"
32	49.5	Rd 58 x 1/6"
40	49.5	Rd 65 x 1/6"
50	49.5	Rd 78 x 1/6"
65	49.5	Rd 95 x 1/6"
80	49.0	Rd 110 x 1/4"
100	71.5	Rd 130 x 1/4"
125	56.5	Rd 160 x 1/4"
150	56.5	Rd 190 x 1/4"

VN | VARIVENT smooth flange

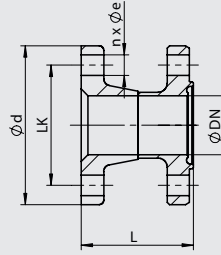

Ø DN	L	Ø d	LK	n x Ø e
10	49.5	-	-	-
15	49.5	-	-	-
25	49.5	70	53	4 x Ø9
32	49.5	-	-	-
40	49.5	82	65	4 x Ø9
50	49.5	94	77	4 x Ø9
65	49.5	113	95	8 x Ø9
80	49.0	128	110	8 x Ø9
100	71.5	159	137	8 x Ø11
125	56.5	183	161	8 x Ø11
150	56.5	213	188	8 x Ø11

SM | SMS threaded connector 1146

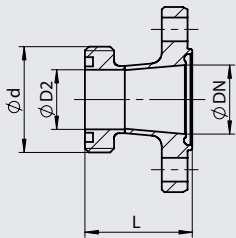

Ø DN	L	Ø D2	Ø d
25	40.5	22.5	Rd 40 x 1/6"
40	45.5	35.5	Rd 60 x 1/6"
50	45.5	48.5	Rd 70 x 1/6"
65	49.5	60.5	Rd 85 x 1/6"
80	51.5	73.1	Rd 98 x 1/6"
100	57.5	97.6	Rd 132 x 1/6"

FG | Hygiene flange, smooth flange

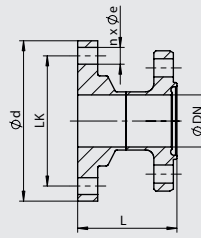

Ø DN	L	Ø d	LK	n x Ø e
10	49.5	-	-	-
15	49.5	62	48	4 x Ø8.4
25	49.5	80	65	4 x Ø8.4
32	49.5	86	71	4 x Ø8.4
40	49.5	92	77	4 x Ø8.4
50	49.5	108	92	4 x Ø8.4
65	49.5	130	110	4 x Ø10.5
80	49.0	146	126	6 x Ø10.5
100	71.5	166	146	8 x Ø10.5
125	56.5	205	180	8 x Ø12.5
150	56.5	240	215	8 x Ø12.5

DF | DIN flange DIN EN 1092-1

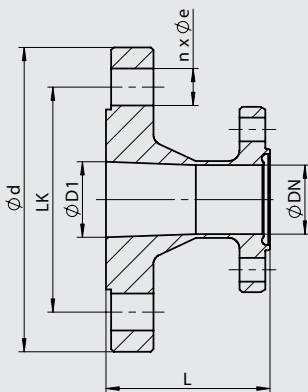

Ø DN	L	Ø D1	Ø d	LK	n x Ø e
10	49.5	10.4	90.0	60.0	4 x Ø14
15	49.5	16.0	95.0	65.0	4 x Ø14
25	62.0	24.8	115.0	85.0	4 x Ø14
32	62.0	32.8	140.0	100.0	4 x Ø18
40	62.0	39.3	150.0	110.0	4 x Ø18
50	62.0	51.2	165.0	125.0	4 x Ø18
65	74.5	70.3	185.0	145.0	8 x Ø18
80	74.0	82.5	200.0	160.0	8 x Ø18
100	71.5	100.8	220.0	180.0	8 x Ø18
125	84.5	125.0	250.0	210.0	8 x Ø22
150	84.5	155.0	285.0	240.0	8 x Ø22

Note

- All dimensions in millimeters [mm].
- "Ø DN" always refers to the pipe diameter of the transmitter.



SS | Weld flange DIN 11853-2

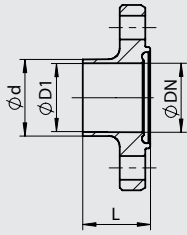

DINA, DIN2		
Ø DN	L	Ø d
10	25.5	13.0
15	25.5	19.0
25	25.5	29.0
32	25.5	35.0
40	25.5	41.0
50	25.5	53.0
65	25.5	70.0
80	27.5	85.0
100	27.5	104.0
125	29.5	129.0
150	29.5	154.0

DINB			
Ø DN	Ø D1	L	Ø d
10	08	25.5	13.5
15	10	25.5	17.2
25	15	25.5	21.3
	20	25.5	26.9
32	25	25.5	33.7
40	32	25.5	42.4
50	40	25.5	48.3
	50	25.5	60.3
65	65	25.5	76.1
80	80	27.5	88.9
100	100	27.5	114.3

DINC, ASME			
Ø DN	Ø D1	L	Ø d
10	1/2"	25.5	12.7
15	3/4"	25.5	19.05
25	1"	25.5	25.4
40	1½"	25.5	38.1
50	2"	25.5	50.8
65	2½"	25.5	63.5
80	3"	25.5	76.2
100	4"	27.5	101.6
150	6"	27.5	152.4

TC | Tri-Clamp DIN 32676 or ASME-BPE

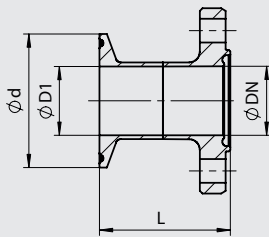

DINA, DIN2		
Ø DN	L	Ø d
10	49.5	34.0
15	49.5	34.0
25	49.5	50.5
32	49.5	50.5
40	49.5	50.5
50	49.5	64.0
65	49.5	91.0
80	49.0	106.0
100	71.5	119.0
125	56.5	155.0
150	56.5	183.0

DINB			
Ø DN	Ø D1	L	Ø d
10	08	49.5	25.0
15	10	49.5	25.0
25	15	49.5	50.5
	20	49.5	50.5
32	25	49.5	50.5
40	32	49.5	64.0
50	40	49.5	64.0
	50	49.5	77.5
65	65	49.5	91.0
80	80	49.0	119.0
100	100	71.5	130.0
125	125	56.5	155.0
150	150	56.5	183.0

DINC, ASME			
Ø DN	Ø D1	L	Ø d
10	1/2"	34.9	25.0
15	3/4"	51.8	25.0
25	1"	50.9	50.5
40	1½"	50.9	50.5
50	2"	50.9	64.0
65	2½"	36.2	77.5
80	3"	47.8	91.0
100	4"	51.1	119.0
150	6"	51.1	183.0

HH | Aseptic fitting 11864-1

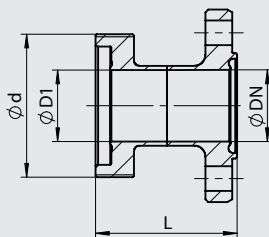

DINA, DIN2		
Ø DN	L	Ø d
10	44.5	Rd 28 x 1/8"
15	44.5	Rd 34 x 1/8"
25	51.5	Rd 52 x 1/6"
32	55.5	Rd 58 x 1/6"
40	56.5	Rd 65 x 1/6"
50	56.5	Rd 78 x 1/6"
65	61.5	Rd 95 x 1/6"
80	69.5	Rd 110 x 1/4"
100	77.5	Rd 130 x 1/4"

DINB			
Ø DN	Ø D1	L	Ø d
10	08	44.5	Rd 28 x 1/8"
15	10	44.5	Rd 34 x 1/8"
25	15	46.5	Rd 44 x 1/6"
	20	51.5	Rd 52 x 1/6"
32	25	55.5	Rd 58 x 1/6"
40	32	56.5	Rd 65 x 1/6"
50	40	56.5	Rd 78 x 1/6"
	50	61.5	Rd 95 x 1/6"
65	65	67.5	Rd 110 x 1/4"
80	80	77.5	Rd 130 x 1/4"

DINC, ASME			
Ø DN	Ø D1	L	Ø d
10	1/2"	44.5	Rd 28 x 1/8"
15	3/4"	44.5	Rd 34 x 1/8"
25	1"	51.5	Rd 52 x 1/6"
40	1½"	56.5	Rd 65 x 1/6"
50	2"	56.5	Rd 78 x 1/6"
65	2½"	61.5	Rd 95 x 1/6"
80	3"	69.5	Rd 110 x 1/4"
100	4"	77.5	Rd 130 x 1/4"

Electrical connection (M12 plug, 4-pin)

- 1: +24 V DC
- 2: 4...20mA
- 3: 0 V DC
- 4: Pulse output

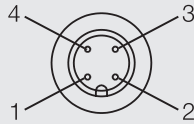

Electrical connection (M12 plug, 5-pin)

- 1: +24 V DC
- 2: 4...20mA
- 3: 0 V DC
- 4: Pulse output
- 5: Switch input

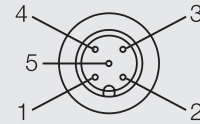

Mechanical Connection / Installation



- For installation please check also the installation remarks mentioned in the product manual.
- **Correct installation:**
 - Before or into an ascending pipe.
- **Wrong installation:**
 - Before or into a descending pipe.
 - Into the highest point of a pipe, air bubbles will concentrate there.

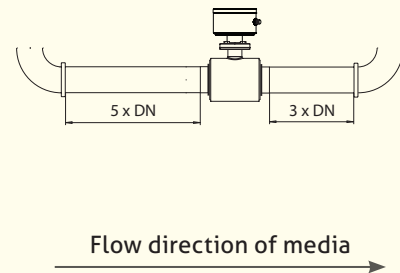
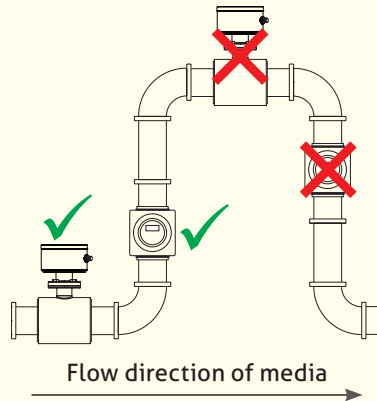

Requirements for a measuring point compliant with the 3-A Sanitary Standard 28-05



- The standard FMQ sensor with process connection SS, TC and HH is 3-A compliant.
- The sensor is designed for CIP/SIP cleaning. Maximum temperature of 130 °C (266 °F) for 30 minutes.
- Mounting position: The mounting position and self-draining properties must be in accordance with the current 3-A Sanitary Standard.

Cleaning/Maintenance



- When using a pressure washer, do not point the nozzle directly at the electrical connections.

Standards and guidelines



- Compliance with the applicable regulations and directives is mandatory.

Transport/Storage



- Do not store outside
- Store in an area that is dry and dust-free
- Do not expose to corrosive media
- Protect against solar radiation
- Avoid mechanical shock and vibration
- Storage temperature 0...60 °C (32...266 °F)
- Relative humidity max. 80%

Reshipment



- Sensors and process connection must be clean and must not be contaminated with hazardous media and/or heat-conductive paste. Please note the cleaning notice!
- To avoid damage of the equipment, use suitable transport packaging only.

Notice on CE



- Applicable directives: Electromagnetic Compatibility Directive 2014/30/EU
- Compliance with the applicable EU directives is identified by the CE label on the product.
- The operating company is responsible for complying with the guidelines applicable to the entire installation.

Disposal



- Electrical devices should not be disposed of with household trash. They must be recycled in accordance with national laws and regulations.
- Take the device directly to a specialized recycling company and do not use municipal collection points.

Measurement accuracy by flow rate

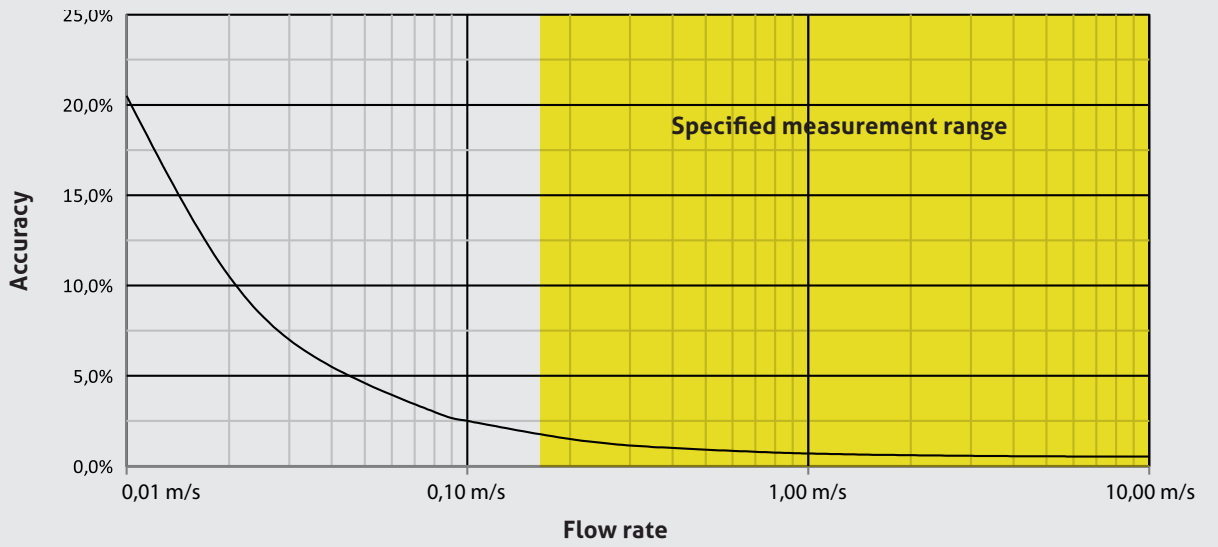

Flow rate nomogram

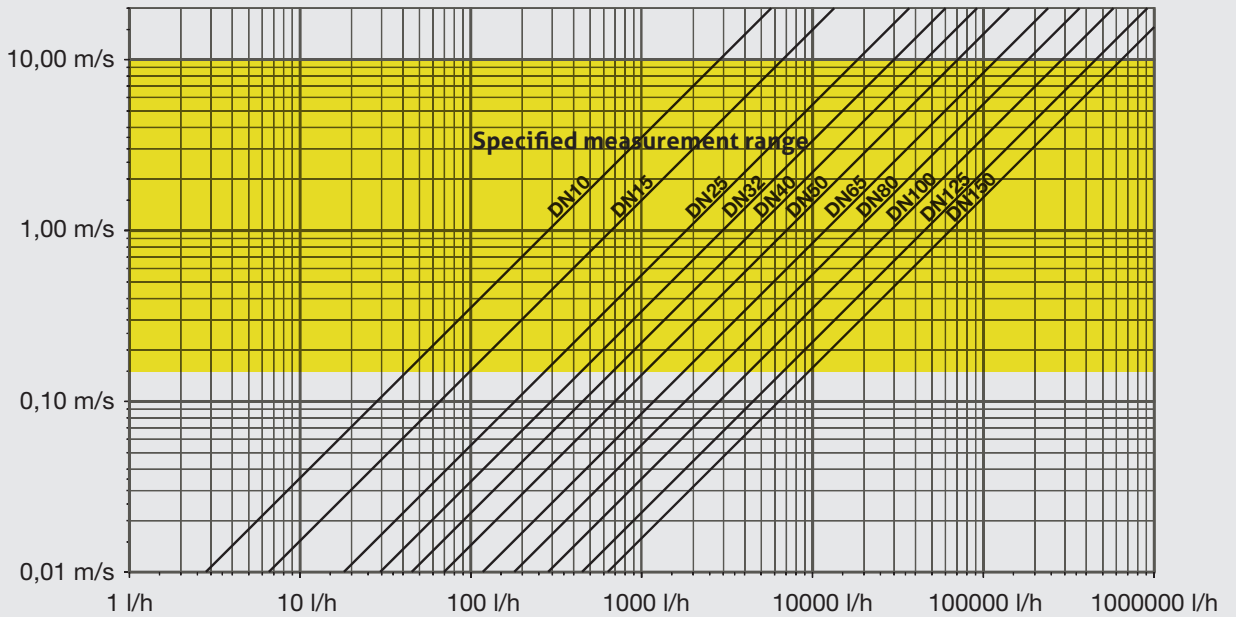

Process connection kit for FMQ

FM-FC Process connection for food applications; material 1.4404 (AISI 316L)

Pipe standard

DIN2 (DIN11850 Series 2)

ASME (OD tube as per ASME-BPE)

Transmitter (fits the specified nominal widths of the process connections as per standard)

DIN2 **ASME**

010 **1/2"** (suitable for transmitter FT010)

015 **3/4"** (suitable for transmitter FT015)

025 **1"** (suitable for transmitter FT025)

032 **-** (suitable for transmitter FT032)

040 **1,5"** (suitable for transmitter FT040)

050 **2"** (suitable for transmitter FT050)

065 **2,5"** (suitable for transmitter FT065)

080 **3"** (suitable for transmitter FT080)

100 **4"** (suitable for transmitter FT100)

125 **-** (suitable for transmitter FT125)

150 **6"** (suitable for transmitter FT150)

Process connection (without 3-A TPV certificate)

GG (milk pipe fitting DIN 11851)

VN (VARIVENT smooth flange)

FG (FG hygiene flange, smooth flange)

DF (DIN flange as per DIN EN 1092-1 Type 11 Form B)

SM (SMS threaded connector 1146)

Process connection (with 3-A TPV certificate as per standard 28-05)

SS (weld flange DIN 11853-2)

TC (Tri-Clamp DIN 32676 or ASME-BPE)

HH (Aseptic fitting DIN 11864-1 threaded side)

Surface

08 ($R_a \leq 0,8 \mu\text{m}$)

FM-FC / DIN2 / 100 / SS / 08

Note

The process connection kit FM-FC (food) contains:

- Process connections made of stainless steel (1.4404/AISI 316L) including the required screws
- Seals EPDM (FDA number 21 CFR 177.2600)



Process connection kit for FMQ

FM-PC Process connection for pharma applications; material 1.4435 (316L) with material certificates

Pipe standard

DINA DIN 11866 Series A (pipe dimension as per DIN 11850 Series 2)
DINB DIN 11866 Series B (pipe dimension as per DIN EN ISO 1127)
DINC DIN 11866 Series C (pipe dimension as per ASME-BPE)

Transmitter (fits the specified nominal widths of the process connections as per standard)

DINA	DINB	DINC	
010	008	1/2"	(suitable for transmitter FT010)
015	010	3/4"	(suitable for transmitter FT015)
025	015	1"	(suitable for transmitter FT025)
-	020	-	(suitable for transmitter FT025)
032	025	-	(suitable for transmitter FT032)
040	032	1,5"	(suitable for transmitter FT040)
050	040	2"	(suitable for transmitter FT050)
-	050	-	(suitable for transmitter FT050)
065	065	2,5"	(suitable for transmitter FT065)
080	080	3"	(suitable for transmitter FT080)
100	100	4"	(suitable for transmitter FT100)
125	125	-	(suitable for transmitter FT125)
150	150	6"	(suitable for transmitter FT150)

Process connection (with 3-A TPV certificate as per standard 28-05)

SS (weld flange DIN 11853-2)
TC (Tri-Clamp DIN 32676 or ASME-BPE)
HH (aseptic fitting DIN 11864-1 threaded side)

Surface

08 ($R_a \leq 0,8 \mu\text{m}$)
04 ($R_a \leq 0,4 \mu\text{m}$)

FM-PC / DINA / 015 / SS / 04

Note

The process connection kit FM-FC (pharma) contains:

- Process connection made of stainless steel (1.4435/AISI 316L) with the associated 3.1 certificate including the required screws
- Seals EPDM (USP Class VI certificate)
- Optional: Surface of the metallic process connections $R_a \leq 0.4 \mu\text{m}$ electropolished

Options for process connection FM-PC (pharma)

RAC / FM-PC Certificate for surface quality of process connections incl. measurement report (1 measuring point)
DFC / FM-PC Certificate for delta ferrite content of process connections incl. measurement report

FMQ compact device with transmitter and head electronics

FMQ Magnetic-inductive flow meter in compact design

Transmitter type

FT010	(meter tube nominal width DN10)
FT015	(meter tube nominal width DN15)
FT025	(meter tube nominal width DN25)
FT032	(meter tube nominal width DN32)
FT040	(meter tube nominal width DN40)
FT050	(meter tube nominal width DN50)
FT065	(meter tube nominal width DN65)
FT080	(meter tube nominal width DN80)
FT100	(meter tube nominal width DN100)
FT125	(meter tube nominal width DN125)
FT150	(meter tube nominal width DN150)

Certificate

S	(no certificate)
P	(3.1 certificates of all wetted parts and factory calibration certificate)

Display

L	(LED status display)
D	(graphic display)

Electrical connection

X	(M12 connector without switch input, 4-pin, plastic)
M12	(M12 connector without switch input, 4-pin, metal)
M	(M12 connector with switch input, 5-pin, metal)

FMQ / FT010 / S / L / X

Accessories**PVC cable with M12 coupling made of 1.4305 (AISI 303), IP 69 K, unshielded**

M12-PVC / 4-5 m	PVC-cable 4-pin, length 5 m
M12-PVC / 4-10 m	PVC-cable 4-pin, length 10 m
M12-PVC / 4-25 m	PVC-cable 4-pin, length 25 m
M12-PVC / 5-5 m	PVC-cable 5-pin, length 5 m
M12-PVC / 5-10 m	PVC-cable 5-pin, length 10 m
M12-PVC / 5-25 m	PVC-cable 5-pin, length 25 m

PVC cable with M12 coupling Nickel-plated brass, IP 67, shielded

M12-PVC / 4G-5 m	PVC-cable 4-pin, length 5 m
M12-PVC / 4G-10 m	PVC-cable 4-pin, length 10 m
M12-PVC / 4G-25 m	PVC-cable 4-pin, length 25 m
M12-PVC / 5G-5 m	PVC-cable 5-pin, length 5 m
M12-PVC / 5G-10 m	PVC-cable 5-pin, length 10 m
M12-PVC / 5G-25 m	PVC-cable 5-pin, length 25 m

FMQ display kit

Display module for FMQ for retrofitting
incl. connection cable, screws and cover

PVC-cable with M12-connection**Graphic display****Options****CERT / 2.2 / FMQ
RE-CAL / FMQ**

Factory certificate 2.2 as per EN 10204 (product-contacting only)
Recalibration of a FMQ (standard calibration certificate,
2 calibration points 4 % and 50 %)

RE-CAL / FMQ / MP

Recalibration of a FMQ (standard calibration certificate,
4 calibration points 4 %, 10 %, 20 % and 50 %)